

# Positive displacement meters series BM 200 - BM 400 - BM 600



BM 200



BM 600



BM 400

[www.isoilmeter.com](http://www.isoilmeter.com)

**ISOIL**  
I M P I A N T I  
The solutions that count

LEAFLET: PR/CO/0003  
Edition April 2015



## Positive displacement meters series BM 200 - BM 400 - BM 600

ISOIL PD meter series **BM** sizes 3", 4" and 6" offers high accuracy:  $\pm 0.1\%$  with a repeatability of  $\pm 0.01\%$ , over a large range of flow rate. This accuracy remains constant during long periods of use.

Visual indication of the flow rate measured can be obtained when associated with mechanical register or electronic flow computer directly mounted on the meter or remote by means of a pulses emitter (see VEGA II or VEGA T leaflets).

### Applications

- » loading and unloading of tank trucks, tank wagons and barges
- » aircraft refuelling
- » transfer of petrochemical products from refineries to depots in pipelines
- » calibration of other meters and tanks

### Filtering and air elimination

To assure a measuring accuracy and preserve the meter from damage, the fluid under measurement must be properly filtered and air or gas must be eliminated. Isoil produces a wide range of strainers and strainer – air separators (see FA - FDA leaflet).

### Operation

While rotating, the vanes are driven by the internal surface of the single body. This means that the self – lubricating vanes are always in contact with the internal surface of measuring chamber, therefore product leakage is avoided and though high accuracy is granted. The calibration mechanism allows micrometric adjustment. It is not necessary to change gears.

When an electronic counter is remote, the meter mounts a pulses emitter or encoder (see Encoder Isoil 6422 data sheet).

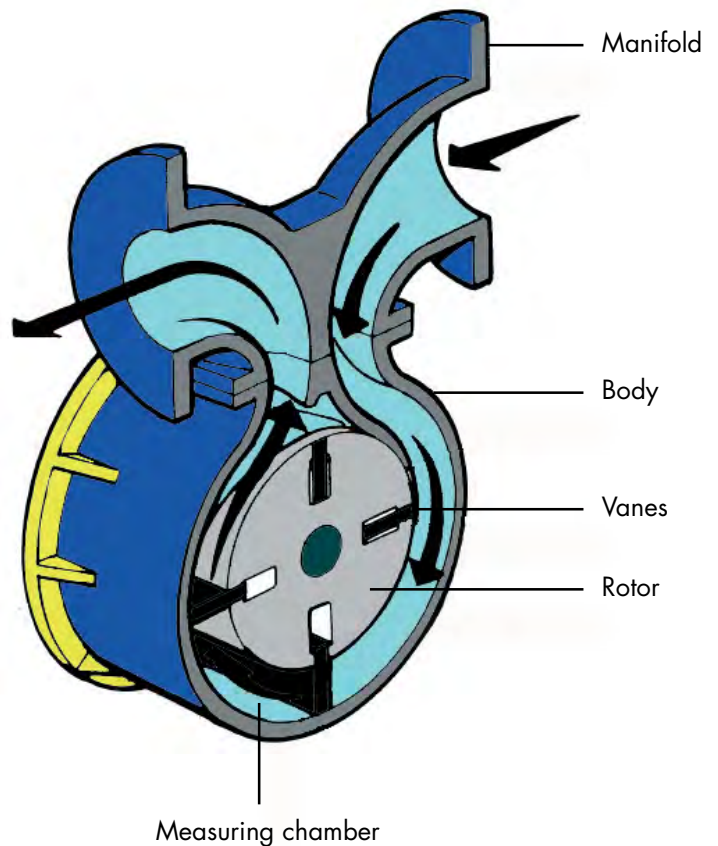

Accuracy curves

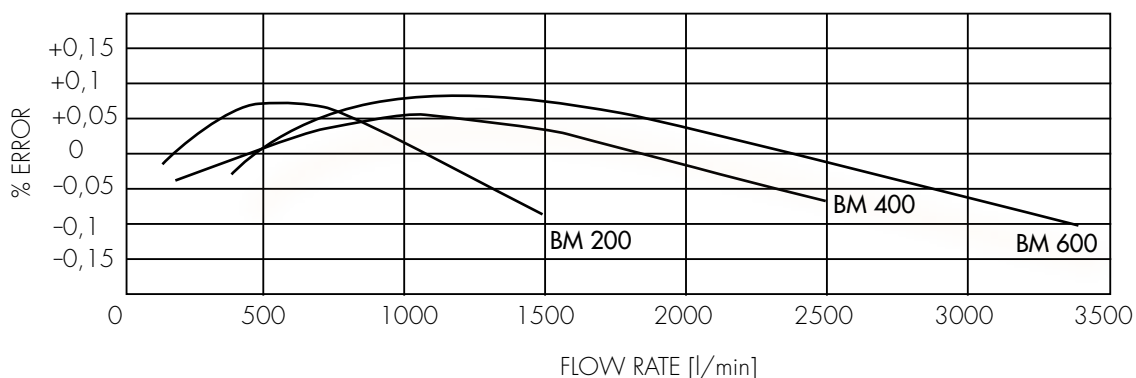

## Technical specifications

	STANDARD			UPON REQUEST
	BM 200	BM 400	BM 600	
<b>EU Directives compliance</b>				
PED (dir. 97/23/CE)	Compliant directive 97/23/CE, with risk category depending on the measured liquid			
ATEX (dir. 94/9/CE)	Non electrical equipment, compliant directive 94/9/CE, suitable for installation in hazardous area II 2G, marking Ex II 2 G c T1 ... T6			
<b>Working conditions</b>				
Flow rate:	[100 ; 1,300] l/min @ 10 cSt	[200 ; 2,400] l/min @ 10 cSt	[300 ; 3,400] l/min @ 10 cSt	
Maximum flow rate avio	1,400 l/min	2,600 l/min	4,000 l/min	
Working pressure:	1,000 KPa max	1,000 KPa max	1,000 KPa max	Higher value
Test pressure:	1,700 KPa	1,700 KPa	1,700 KPa	
Working temperature:	[-30; +100] °C *	[-30; +100] °C *	[-30; +100] °C *	Higher and lower values
<b>Construction</b>				
Manifold and flanges:	Carbon Steel	Carbon Steel	Carbon Steel or Aluminium (avio)	
Body:	Carbon Steel with corrosion prevention treatment	Carbon Steel with corrosion prevention treatment	Carbon Steel with corrosion prevention treatment	
Covers:	Carbon Steel with corrosion prevention treatment	Carbon Steel with corrosion prevention treatment	Carbon Steel with corrosion prevention treatment	
Rotor:	Aluminium	Aluminium	Aluminium	Stainless Steel SS316
Vanes:	Graphite	Graphite	Graphite	PTFE
Gaskets:	Nitrile	Nitrile	Nitrile	Viton or PTFE
Ball bearings:	Stainless Steel	Stainless Steel	Stainless Steel	Graphite bushes
Seal:	Viton lip seal	Viton lip seal	Viton lip seal	Mechanical or magnetic drive
Flanged:	3" ANSI150 RF	4" ANSI150 RF	6" ANSI150 RF or FF (avio)	Other sizes and standards
Readout (with mechanical register)	litres	litres or m <sup>3</sup>	m <sup>3</sup>	Others
Flow direction:	Left (IN) to right (OUT)	Left (IN) to right (OUT)	Left (IN) to right (OUT)	Right (IN) to left (OUT)
<b>Performances</b>				
Accuracy:	± 0.1%	± 0.1%	± 0.1%	
Repeatability:	± 0.01%	± 0.01%	± 0.01%	
Pressure drop:	Refer to the diagram attached	Refer to the diagram attached	Refer to the diagram attached	

\*Temperature range, printed on plate, will always span 60° C

### Pressure drop curves

Viscosity at 15°C = 2 cSt  
Density = 795 Kg/m<sup>3</sup>

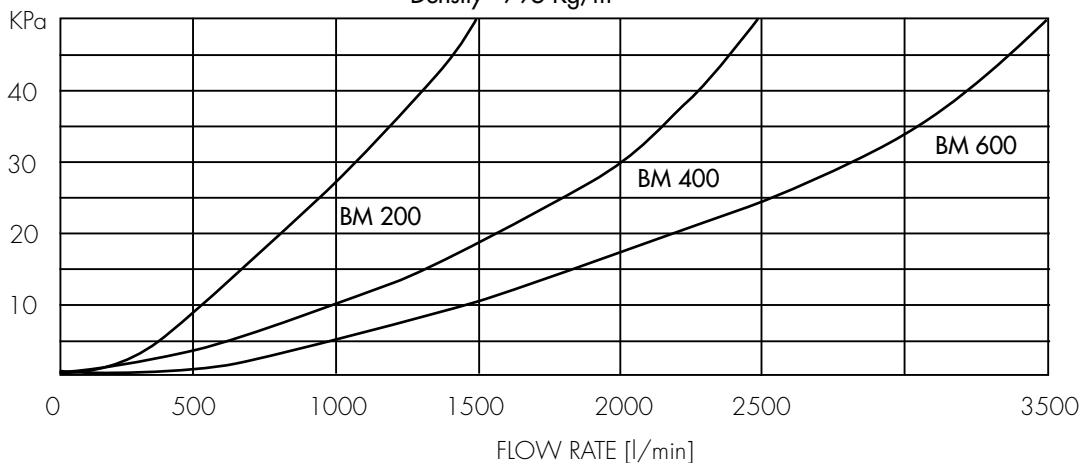

## Accessories

### Pulses emitter

Encoder 6422 Ex-d. Pulses emitter EM 345 Eex-i or EM T2 Exd incorporated in Veeder Root 7887 register

### With VEGA II compensation

Is achieved by an algorithm based on "alfa" coefficient or density

### Unit drum (for Master Meter)

Allows the reading of 1/10 of the last digit

### Instant flow rate

Mechanical needle indicator

### Ticket printer

Veeder Root. Zero start or cumulative

### Preset

Veeder Root 7889, with one or two pneumatic micro switches or electric micro switches Ex-d ATEX

### Extension for mechanical counter

L = 250 mm, 500 mm, 1000 mm and 3000 mm

### ISOVALVE automatic valve

3" or 4" or 6". 2 stages or Multistep closure. Flow limiting. No return

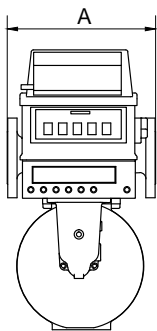

**BM 200**

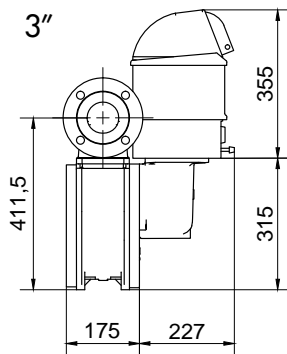

**BM 400**

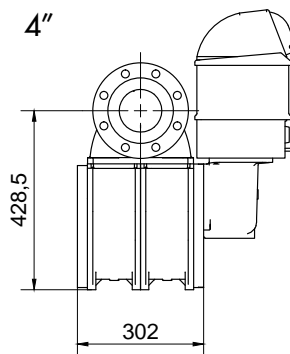

**BM 600**

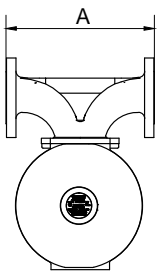
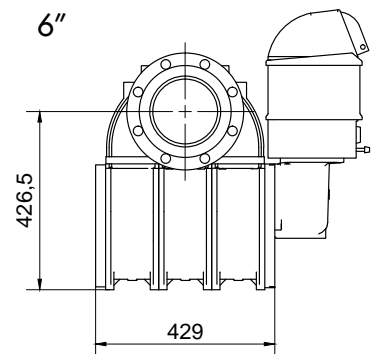

**BM 200**

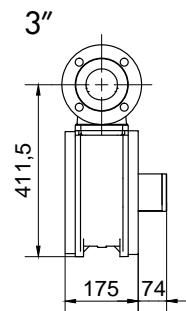

**BM 400**

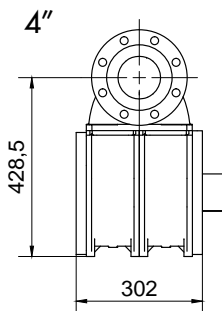

**BM 600**

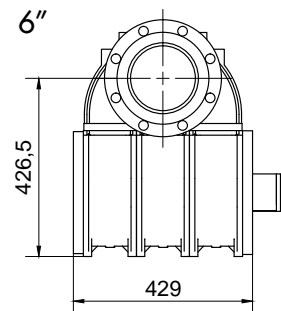

Type	Dimension A	Weight
<b>BM 200</b>	356 mm	70 Kg
<b>BM 400</b>	430 mm	102 Kg
<b>BM 600</b>	733 mm	155 Kg

Accessories	Weight
<b>VR Counter</b>	6 Kg
<b>Preset</b>	5 Kg
<b>Printer</b>	5 Kg